

Article number: 03505025

Description: Fluro Rod end GE 25FO

## Measures

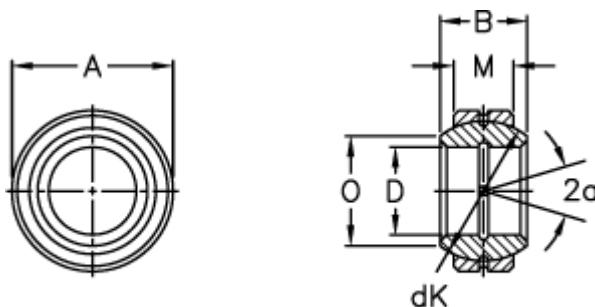

Str. 6–12 uden smørerille

A	= 47 0 -0,011	Tilt angle = 17
B	= 28	Weight = 190
D	= 25 0 -0,010	
dK	= 40.7	
Dynamic load C (kN)	= 62	
M	= 18	
O	= 29.5	
Static load C0 (kN)	= 310	